

KOMATSU

1.5 - 3.5 ton

DIESEL and GASOLINE FORKLIFT TRUCKS



Destined Evolution

Workability

- ✔ Smooth starting even while performing stationary steering
- ✔ Easy lifting without revving up engine
- ✔ Free stationary steering to change steering direction with light effort
- ✔ Thoughtful consideration of comfortable operation

Ecology

- ✔ EPA Tier3/EU Stage IIIA Compliant Diesel Engine
- ✔ Powerful lift truck with lower fuel consumption



Komatsu 1.5-3.5ton Diesel and Gasoline Forklift Trucks that reviewed the performance required from a lift truck has unrivaled performance and functions clearly different from those of competitors.

Increased safety, reduced total lifetime costs, high operability with less fatigue, and environmental performance carefully considered.

You will certainly be satisfied with Komatsu's unique benefits. These features will be the true standard for the future, providing increased satisfaction on the job.



Safety

- ▀ Operator Presence Sensing System
- ▀ Superior Visibility

Comfort

- ▀ Dual 'Floating' Structure
- ▀ Wide Floor and Open, Non-slip Step
- ▀ Increased Operator Head Clearance

1.5 - 1.75ton Trucks

- Standard model
- 1.5 ton
- 1.75 ton
- [Diesel]
- [Gasoline]



2.0 - 3.5ton Trucks

- Standard model
- 2.0 ton
- 2.5 ton
- 3.0 ton
- 3.5 ton
- [Diesel]
- [Gasoline]



Satisfying high workability and environmental performance required by the jobsite



Excellent lifting performance to speed up work

Super Lift Hydraulic System*

The tandem pump operates the power steering and the lifting equipment independently. Komatsu's hydraulic technology lifts the cargo at about double the lift speed of the previous model when idling. The truck also features fine adjustments for the fork position and superior operability of attachments when idling.

*The Super Lift Hydraulic Systems available on the 2.0-3.5 ton Trucks.

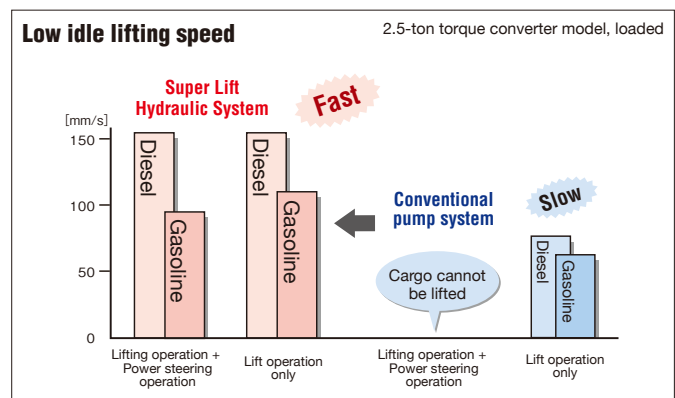
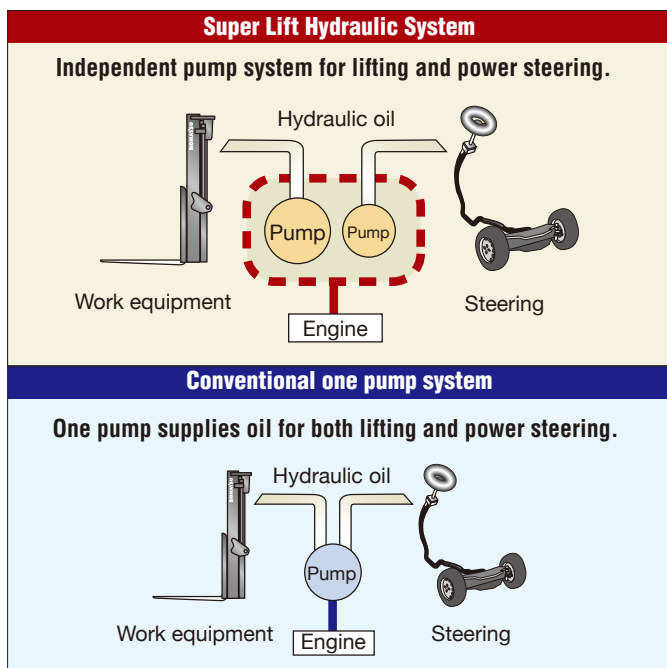

Excellent starting performance even at a jobsite where stationary steering is often required

Super Lift Hydraulic System* allows operator to perform stationary steering and start the truck smoothly without revving up the engine. Even in that case, the engine does not stall. This system is highly appreciated at jobsites where stationary steering is often required.

*The Super Lift Hydraulic Systems available on the 2.0-3.5 ton Trucks.

Starting while performing stationary steering



● Conventional pump system



● Super Lift Hydraulic System

Komatsu Reliability

Komatsu's unique designs have further extended the life span of the truck. Both the new frame structure and changes to the mast improve durability. Improvement of the heat balance also enhances reliability during heavy operations. The meantime between failures (MTBF) has been extended by 40% plus. Maintenance and repair costs are minimized by extensive testing and quality inspections under different operating environments.

Durability improved 40% Up

(Compared with previous model)

Exceptional Heat Balance

The bell-shaped shroud concentrates cooling air into the radiator. The unique shape of the counterweight opening and fan improves cooling performance by increasing the airflow of cooling air. Plus, the Super Lift Hydraulic System* is designed to reduce oil pressure loss, which also prevents the oil temperature from overheating.

*The Super Lift Hydraulic Systems available on the 2.0-3.5 ton Trucks.

Travel control as intended

Small diameter steering wheel and fully hydrostatic power steering mechanism.

The small diameter steering wheel provides 100% stationary steering and switch backs. The superior responsiveness of the steering wheel optimizes maneuverability even in narrow spaces. Fluctuations during traveling have also been reduced by more than 30% to improve travel performance.



Consideration for Comfortable Operation

Komatsu's Research and Development team considers operators. Every aspect concerning an operator's comfort and ease of use have been thoroughly studied and implemented in each design. For instance, the control indicators and levers have been ergonomically designed and arranged in accessible and visible locations.

Komatsu prides itself on developing products, which are designed to optimize both comfort and productivity.



Combination switch (turn signal light and light switch)



Electric forward/reverse lever (TORQFLOW model)



Control levers designed for fingertip control.



Double-cone synchronized clutch (clutch model)

Pursuing environmental performance

EPA Tier3 and EU Stage IIIA compliant diesel engines

Diesel engines that incorporate Komatsu's advanced engine technologies feature excellent environmental performance and conform to the world latest EPA Tier3 and EU Stage IIIA emission regulations.

The diesel engines mounted on the 2.0-3.5 ton Trucks reduce particulate matter (PM) in the exhaust gases by 30% to reduce environmental load.

Powerful engine with low fuel consumption

Thanks to the EPA Tier3 and EU Stage IIIA compliant engine and the Super Lift Hydraulic System*¹, fuel consumption is reduced and powerful performance is realized. Fuel consumption is further improved by 8%*² and CO₂ emissions are also reduced.

*¹ The Super Lift Hydraulic Systems available on the 2.0-3.5 ton Trucks.

*² Measurements of test conducted on Komatsu test course, comparison with FD25T-16.

Comfort and safe design pursued thoroughly from the viewpoint of operators



Less fatigue even after long work periods

Dual 'Floating' Structure

Komatsu's original suspension cab design has evolved. The wide-set front mounts and high position rear mounts allow the entire cabin to float on the chassis. The power train floats the engine and transmission on the frame, and a universal joint is used to reduce engine and motion vibrations on the front axle. The combined technology of both of these Komatsu designed systems further reduce the vibrations transferred to the mast, fork, steering wheel and control lever, as well as the operator's seat. Therefore, ultimately improving operator comfort and cargo safety.

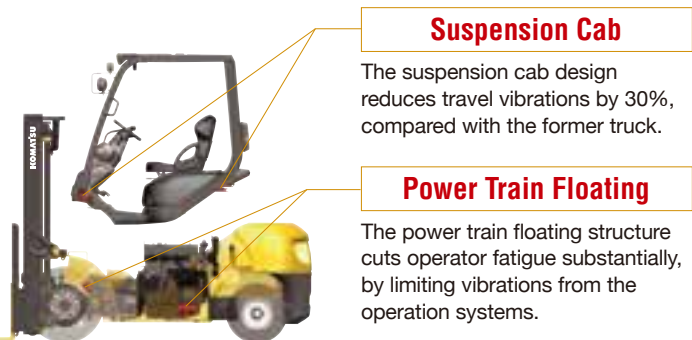

New Suspension Seat

This seat is wide, offers waist support and thus enables the operator to sit in a relaxed state. An assist grip is mounted on the left side for easy getting on and off. Thus, provides comfortable work space and reduces operator's fatigue.

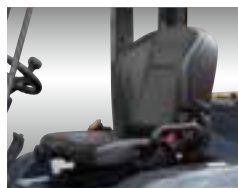

- Wide seat surface
- Orange seat belt
- Assist grip
- Seat position adjustment
- Seat reclining
- Seat suspension adjustment

Wide Floor and Open, Non-Slip Step



The wide, flat floor accommodates the tilt cylinder under the floor. Suspended (type) pedals are used to provide extra foot space, which significantly reduces operator fatigue. The new wide-open, non-slip step and spoon-curved fender makes getting in and out easy and safe.

Safe design to prevent careless mistakes

Operator Presence Sensing System (Lifting/Traveling Interlocking Mechanism) **OPTION**

The Operator Presence Sensing System is a safety option that only allows lifting operations while traveling, when the operator is seated. The alarm is activated once the operator leaves the seat. The interlock is a double safety measure and remains activated even when the operator returns to the seat. The interlock can only be released by returning the respective levers to a safe position.

Traveling Interlocking Mechanism cuts power transmission off but does not serve to apply the brake. This mechanism is not installed on the lift truck with a clutch.



The interlock state is also indicated on the meter panel.

Superior Visibility

The mast rail section has been flattened and the inside width expanded for superior front visibility. With the lowered position of 3-stage mast center cylinder and the tilt stay, plus the inclined backrest, front visibility is improved, and blind spots are reduced. The 2.0-3.5 ton Trucks also provides clear fork tip visibility. The size and layout of the dashboard and meter panel are optimized.



Easy rear confirmation

The wide-angle center mirror provides a greater sight area for safety traveling.



A Neutral Start Function for Preventing a Sudden Start



Neutral indicator for at-a-glance information.

The engine cannot be started unless the F-R switch is in the neutral position.

Parking Brake Alarm



A double caution type brake lever prevents mishandling.

Safe Travel in Reverse

The upper corners of the counterweight are inclined to improve visibility. The edge of the counterweight, which is visible from the operator's seat, is designed to provide better visibility when confirming distances while reversing. The new counterweight outlets are flow-directional, which are designed to prevent hot air from blowing onto the operator while reversing. The tail pipe has also been repositioned and is now located at the lowest point of the counterweight. This improves driver comfort and prevents stains that are caused by exhaust gas.



Specifications

Model	Manufacturer's Designation		Transmission	FG15-21 TORQFLOW	FD15-21 TORQFLOW	FG15H-21 TORQFLOW	FG18-21 TORQFLOW	FD18-21 TORQFLOW	FG18H-21 TORQFLOW	FG20-17 TORQFLOW
	1.2	Electric, Diesel, Gasoline, LPG			Gasoline	Diesel	Gasoline	Gasoline	Diesel	Gasoline
1.3	Operation Type			Sitting	Sitting	Sitting	Sitting	Sitting	Sitting	Sitting
1.4	Rated Capacity	Q	Rated Capacity	kg	1500	1500	1500	1750	1750	2000
1.5	Load Center	c	Rated Load Center	mm	500	500	500	500	500	500
1.6	Alternative Capacity	Q2	Capacity@600mm Load Center	kg	1350	1350	1350	1570	1570	1810
1.6.1	Load Distance	x	Front Axle Center to Fork Face	mm	405	405	405	405	405	460
1.7	Wheelbase	y		mm	1400	1400	1400	1400	1400	1650
2.1	Service Weight			kg	2450	2550	2450	2645	2745	2645
2.2	Axle Loading	Loaded	Front	kg	3500	3530	3500	3870	3900	3870
2.2.1			Rear	kg	450	520	450	525	595	525
2.3		Unloaded	Front	kg	1005	1035	1005	960	990	960
2.3.1			Rear	kg	1445	1515	1445	1685	1755	1685
3.1	Tyre Type			Pneumatic	Pneumatic	Pneumatic	Pneumatic	Pneumatic	Pneumatic	Pneumatic
3.2	Tyre Size	Front		6.50-10-10PR(I)	6.50-10-10PR(I)	6.50-10-10PR(I)	6.50-10-10PR(I)	6.50-10-10PR(I)	6.50-10-10PR(I)	7.00-12-12PR(I)
3.3		Rear		5.00- 8- 8PR(I)	5.00-8-8PR(I)	5.00- 8- 8PR(I)	5.00- 8- 8PR(I)	5.00-8-8PR(I)	5.00- 8- 8PR(I)	6.00-9-10PR(I)
3.5	Number of Wheels	Front/Rear (x=driven)			2x/2	2x/2	2x/2	2x/2	2x/2	2x/2
3.6	Tread, Front	b4		mm	890	890	890	890	890	965
3.7	Tread, Rear	b3		mm	895	895	895	895	895	960
4.1	Tilting Angle	α/β	Forward/Backward	degree	6/10	6/10	6/10	6/10	6/10	6/12
4.2	Mast Height, Lowered	h1	2-stage Mast	mm	1995	1995	1995	1995	1995	1995
4.3	Std. Free Lift	h2	2-stage Std. Mast, from Ground	mm	140	140	140	140	140	150
4.4	Std. Lift Height	h3	2-stage Std. Mast, from Ground	mm	3000	3000	3000	3000	3000	3000
4.5	Mast Height, Extended	h4	2-stage Std. Mast	mm	3955	3955	3955	3955	3955	4050
4.7	Height, Overhead Guard	h6		mm	2070	2070	2070	2070	2070	2110
4.19	Length, with Std. Forks	L1		mm	3160	3160	3160	3200	3200	3450
4.20	Length, to Fork Face	L2		mm	2240	2240	2240	2280	2280	2530
4.21	Width, at Tyre	b1	Single	mm	1070	1070	1070	1070	1070	1150
4.22	Forks	s/e/l	Thickness x Width x Length	mm	35x100x920	35x100x920	35x100x920	35x100x920	35x100x920	35x100x920
4.23	Fork Carriage Class	ISO 2328, Type A/B/no			Class 2,A	Class 2,A	Class 2,A	Class 2,A	Class 2,A	Class 2,A
4.24	Width, Fork Carriage	b2		mm	970	970	970	970	970	1020
4.31	Ground Clearance	m1	Under Mast	mm	120	120	120	120	120	115
4.32		m2	at Center of Wheelbase	mm	130	130	130	130	130	160
4.33	Right Angle Stacking Aisle	Ast	with L1000 x W1200 pallet	mm	3360	3360	3360	3395	3395	3650
4.34		Ast	with L1200 x W800 pallet	mm	3560	3560	3560	3595	3595	3850
4.35	Turning Radius	Wa		mm	1955	1955	1955	1990	1990	2190
5.1	Travel Speed (FWD)	Loaded, 1st/2nd	km/h	18.5	18.5	18.5	18.5	18.5	18.5	18.5
5.2		Unloaded, 1st/2nd	km/h	19.0	19.0	19.0	19.0	19.0	19.0	19.0
5.2	Lifting Speed	Loaded	mm/s	570	620	590	570	620	590	545
5.3		Unloaded	mm/s	640	670	640	640	670	640	600
5.3	Lowering Speed	Loaded	mm/s	500	500	500	500	500	500	450
5.6		Unloaded	mm/s	550	550	550	550	550	550	500
5.6	Max. Drawbar Pull	Loaded	KN	10	13	15	10	13	15	14
5.8	Max. Gradeability	Loaded	%	26	33	37	25	29	33	28
5.10	Service Brake	Operation/Control			Foot/Hydraulic	Foot/Hydraulic	Foot/Hydraulic	Foot/Hydraulic	Foot/Hydraulic	Foot/Hydraulic
5.11	Parking Brake	Operation/Control			Hand/Mechanical	Hand/Mechanical	Hand/Mechanical	Hand/Mechanical	Hand/Mechanical	Hand/Mechanical
5.12	Steering	Type			FHPS	FHPS	FHPS	FHPS	FHPS	FHPS
6.4	Battery	Voltage/ Capacity at 5-hour rating		V/ah	12/33	12/64	12/33	12/33	12/64	12/33
7.1	Maker Model				GCT GK15	Komatsu 4D92E	GCT GK21	GCT GK15	Komatsu 4D92E	GCT GK21
7.2	Rated Output, SAE net			KW	27.2@2500	34.6@2450	34.6@2450	27.2@2500	34.6@2450	34.6@2450
7.3	Rated RPM			min-1	2500	2450	2450	2500	2450	2450
7.3.1	Max. Torque, SAE net			Nm@min-1	113@1600	142@1800	152@1600	113@1600	142@1800	152@1600
7.4	No. of Cylinders/Displacement			cm ³	4-1486	4-2659	4-2065	4-1486	4-2659	4-2065
7.6	Fuel Tank Capacity			Ltr	40	40	40	40	40	58
8.2	Relief Pressure for Attachment			bar	172	172	172	172	172	181

1.5-1.75 ton Standard Model

Load capacity curve 2-stage free view mast

Model ■ FG15,FD15,FG15H

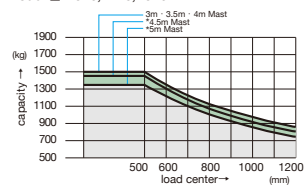

Model ■ FG18,FD18,FG18H

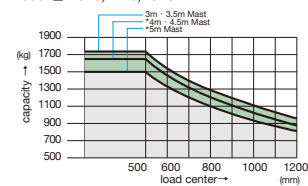

Note 1: Load capacity at other than the 500mm load center reference only.
Note 2: Values when double front tyres are installed.

2.0-3.5 ton Standard Model

Load capacity curve 2-stage free view mast

Model ■ FG20,FD20

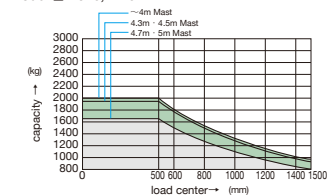

Model ■ FG30,FD30,FD30H

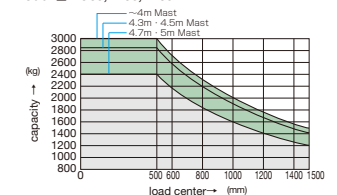

Model ■ FG25,FD25,FG25H,FD25H

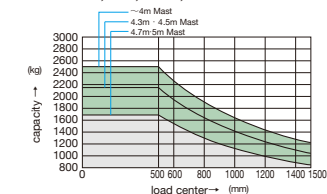

Model ■ FG35AT,FD35AT

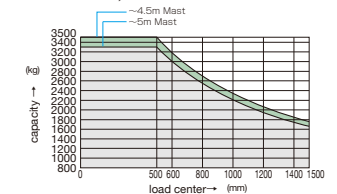

Note: Load capacity at other than the 500mm load center reference only.

FD20-17 TORQFLOW	FG25-17 TORQFLOW	FD25-17 TORQFLOW[Clutch]	FG25H-17 TORQFLOW	FD25H-17 TORQFLOW	FG30-17 TORQFLOW	FD30-17 TORQFLOW[Clutch]	FD30H-17 TORQFLOW	FG35AT-17 TORQFLOW	FD35AT-17 TORQFLOW
Diesel	Gasoline	Diesel	Gasoline	Diesel	Gasoline	Diesel	Diesel	Gasoline	Diesel
Sitting	Sitting	Sitting	Sitting	Sitting	Sitting	Sitting	Sitting	Sitting	Sitting
2000	2500	2500	2500	2500	3000	3000	3000	3500	3500
500	500	500	500	500	500	500	500	500	500
1810	2260	2260	2260	2260	2720	2720	2720	3180	3180
460	465	465	465	465	490	490	490	505	505
1650	1650	1650	1650	1650	1700	1700	1700	1700	1700
3305	3590	3680[3720]	3590	3680	4210	4310[4345]	4310	4910	4950
4710	5420	5475[5495]	5420	5475	6390	6435[6460]	6435	7440	7430
595	670	705[725]	670	705	820	875[885]	875	970	1020
1520	1430	1470[1500]	1430	1470	1600	1640[1670]	1640	1820	1810
1785	2160	2210[2220]	2160	2210	2610	2670[2675]	2670	3090	3140
Pneumatic	Pneumatic	Pneumatic	Pneumatic	Pneumatic	Pneumatic	Pneumatic	Pneumatic	Pneumatic	Pneumatic
7.00-12-12PR(I)	7.00-12-12PR(I)	7.00-12-12PR(I)	7.00-12-12PR(I)	7.00-12-12PR(I)	28x9-15-12PR(I)	28x9-15-12PR(I)	28x9-15-12PR(I)	250-15-16PR(I)	250-15-16PR(I)
6.00-9-10PR(I)	6.00-9-10PR(I)	6.00-9-10PR(I)	6.00-9-10PR(I)	6.00-9-10PR(I)	6.50-10-10PR(I)	6.50-10-10PR(I)	6.50-10-10PR(I)	6.50-10-12PR(I)	6.50-10-12PR(I)
2x/2	2x/2	2x/2	2x/2	2x/2	2x/2	2x/2	2x/2	2x/2	2x/2
965	965	965	965	965	1005	1005	1005	1060	1060
960	960	960	960	960	965	965	965	965	965
6/12	6/12	6/12	6/12	6/12	6/12	6/12	6/12	6/12	6/12
1995	1995	1995	1995	1995	2070	2070	2070	2100	2100
150	155	155	155	155	160	160	160	140	145
3000	3000	3000	3000	3000	3000	3000	3000	3000	3000
4050	4050	4050	4050	4050	4275	4275	4275	4280	4280
2110	2110	2110	2110	2110	2130	2130	2130	2145	2145
3450	3655	3655	3655	3655	3775	3775	3775	3865	3865
2525	2585	2580	2585	2580	2705	2705	2705	2790	2795
1150	1150	1150	1150	1150	1235	1235	1235	1290	1290
36x122x920	40x122x1070	40x122x1070	40x122x1070	40x122x1070	45x122x1070	45x122x1070	45x122x1070	50x150x1070	50x150x1070
Class 2,A	Class 2,A	Class 2,A	Class 2,A	Class 2,A	Class 3,A	Class 3,A	Class 3,A	Class 3,A	Class 3,A
1020	1020	1020	1020	1020	1060	1060	1060	1060	1060
115	115	115	115	115	135	135	135	135	135
160	160	160	160	160	185	185	185	185	185
3650	3775	3775	3775	3775	3930	3930	3930	4055	4055
3850	3905	3905	3905	3905	4060	4060	4060	4185	4185
2190	2240	2240	2240	2240	2370	2370	2370	2480	2480
18.5	18.5	18.5[8.5/18.5]	19.0	18.5	18.5	17.0[7.5/17.0]	18.5	18.0	18.0
19.0	19.0	19.0[8.5/19.0]	19.5	19.0	19.5	17.5[8.0/17.5]	19.0	19.0	18.5
590	545	590	620	660	515	490	550	410	450
630	600	630	670	710	550	530	595	450	490
450	450	450	450	450	420	420	420	400	420
500	500	500	500	500	500	500	500	400	400
14	14	14[13]	19	18	18	14[14]	17	17	17
28	23	23[22]	32	31	26	20[20]	25	20	21
Foot/Hydraulic	Foot/Hydraulic	Foot/Hydraulic	Foot/Hydraulic	Foot/Hydraulic	Foot/Hydraulic	Foot/Hydraulic	Foot/Hydraulic	Foot/Hydraulic	Foot/Hydraulic
Hand/Mechanical	Hand/Mechanical	Hand/Mechanical	Hand/Mechanical	Hand/Mechanical	Hand/Mechanical	Hand/Mechanical	Hand/Mechanical	Hand/Mechanical	Hand/Mechanical
FHPS	FHPS	FHPS	FHPS	FHPS	FHPS	FHPS	FHPS	FHPS	FHPS
12/64	12/33	12/64	12/33	12/64	12/33	12/64	12/64	12/33	12/64
Komatsu 4D94LE	GCT K21	Komatsu 4D94LE	GCT GK25	Komatsu 4D98E	GCT GK25	Komatsu 4D94LE	Komatsu 4D98E	GCT GK25	Komatsu 4D98E
34.2@2200	34.6@2450	34.2@2200	42.6@2400	44.1@2450	42.6@2400	34.2@2200	44.1@2450	42.6@2400	44.1@2450
2200	2450	2200	2400	2450	2400	2200	2450	2400	2450
162@1500	152@1600	162@1500	186@1600	183@1500	186@1600	162@1500	183@1500	186@1600	183@1500
4-3052	4-2065	4-3053	4-2488	4-3318	4-2488	4-3053	4-3318	4-2488	4-3318
58	58	58	58	58	58	58	58	58	58
181	181	181	181	181	181	181	181	181	181

Dimensions

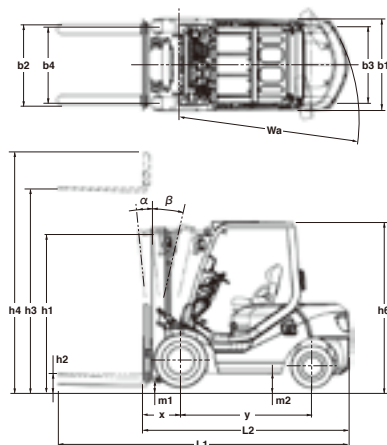

Major equipment

● : Standard ○ : Option - : N/A

Vehicle type		1.5-1.75 ton trucks		2.0-3.5 ton trucks		
Engine		Gasoline	Diesel	Gasoline	Diesel	
Transmission		TORQFLOW	TORQFLOW	TORQFLOW	Clutch	TORQFLOW
Driving/operation	Dual floating structure	●	●	●	●	●
	New operator's seat with suspension	●	●	●	●	●
	Small-sized steering wheel	●	●	●	●	●
	Tiltable steering column	●	●	●	●	●
	Electric forward/reverse lever (TORQFLOW model)	●	●	●	—	●
	Double-cone synchronized clutch (clutch model)	—	—	—	●	—
	Combination switch (turn signal light and light switch)	●	●	●	●	●
	Indicator auto-return mechanism	●	●	●	●	●
	Full-open step	●	●	●	●	●
	Under-floor tilt cylinder	●	●	●	●	●
	Paper binder	●	●	●	●	●
	Glove box	●	●	●	●	●
	Meters	Meter panel	●	●	●	●
Hourmeter		●	●	●	●	●
Engine water temperature gauge		●	●	●	●	●
Fuel gauge		●	●	●	●	●
Indicators	Engine oil pressure warning lamp	●	●	●	●	●
	Charge warning lamp	●	●	●	●	●
	Neutral indicator	●	●	●	●	●
	Sedimenter warning lamp	—	●	—	●	●
	Glow indicator	—	●	—	●	●
Electric components	Full-transistor-type IC distributor	●	—	●	—	—
	Alternator with built-in IC regulator	●	●	●	●	●
	Quick auto glow system	—	●	—	●	●
	Neutral Start mechanism	●	●	●	●	●
	Auto fuse	●	●	●	●	●
	Low maintenance battery	●	●	●	●	●
	Engine key stop mechanism	—	●	—	●	●
	Halogen headlight	●	●	●	●	●
	Rear combination light	●	●	●	●	●
	Back-up buzzer	●	●	●	●	●
Mechanism	Operator Presence Sensing System	○	○	○	○	○
	Auto choke	●	—	●	—	—
	Super Lift Hydraulic System	—	—	●	●	●
	Self-adjustment clutch	—	—	—	●	—
	Sedimentary with priming pump	—	●	—	●	●
	Cyclone air cleaner	●	●	●	●	●
	Parking brake with release button	●	●	●	●	●
	Fully hydrostatic power steering	●	●	●	●	●
	Steering synchronizer function	○	○	○	○	○
	Soft landing mast system	●	●	●	●	●
Exterior	Non-asbestos brake linings	●	●	●	●	●
	Non-asbestos clutch disk	—	—	—	●	—
	Floor mat	●	●	●	●	●
	Assist grips	●	●	●	●	●
	Head guard with front/rear conduits	●	●	●	●	●
	Wide angle center mirror	●	●	●	●	●
	Full shield solid-state engine hood	●	●	●	●	●
	One-touch open floor panel	●	●	●	●	●
	One-touch removable radiator cover	●	●	●	●	●
	Engine hood stopper	●	●	●	●	●
	Engine hood lock	●	●	●	●	●
	Radiator reservoir tank	●	●	●	●	●
	Resin dashboard cover	●	●	●	●	●
Jacking points	●	●	●	●	●	

Optional Specification Truck

■LPG Specification truck

Komatsu offers both single fuel (LPG) and dual fuel (LPG and Gasoline) systems for the LPG Specification truck. The truck has superior fuel consumption, the service life of the engine oil, filters, and plugs are extended, and the engine delivers clean combustion exhaust gases. Cold starts are possible even in temperatures as low as -5°C.



●The sunken counterweight specification truck with an expanded rear view area. (optional for the 1.5-1.75ton LPG trucks)

By lowering the position of the LPG cylinder, installation and removal is easier, and permits a wider rear view area for greater reversing safety.

●Swing-down Bracket (optional for the 1.5-1.75ton LPG trucks)

The LPG cylinder is easily installed and removed in a lower position with minimal effort.



Options

●Steel Cabin*

The steel cabin provides superior comfort and protection from severe cold or very noisy environments. Heaters and air conditioners are also available.

●Protective Resin Head Guard Cover

The resin cover resists stains and provides protection from the rain.

●Digital Load Checker

Loads are measured and displayed in 10 kg units.



●Operator Presence Sensing System



Engine and Operation Equipment

- Radiator screen*
- Pre-cleaner*

Exterior parts

- Tilt cylinder boots*
- Power steering cylinder boots*
- Fuelcap with key

Electrical Equipment

- Yellow strobe light
- Red strobe light
- Rear working light
- Front working light

Meters and Gauges

- Speedometer (with alarm)
- Mast tilt angle gauge*

*Except for 1.5-1.75 ton trucks

Attachments



■ Roll clamp



■ Side shifter



■ Bale clamp



■ Rotating fork



■ Hinged fork

●Although specifications are provided for attachments, some attachments cannot be installed on specific masts depending on their types.
●For details, please contact Komatsu Forklift's dealers.

<https://home.komatsu/en/>

Printed in Japan 201803TP

KOMATSU[®]

Form No.BR-AXBX50-003

Materials and specifications are subject to change without notice
KOMATSU is a trademark of Komatsu Ltd. Japan